

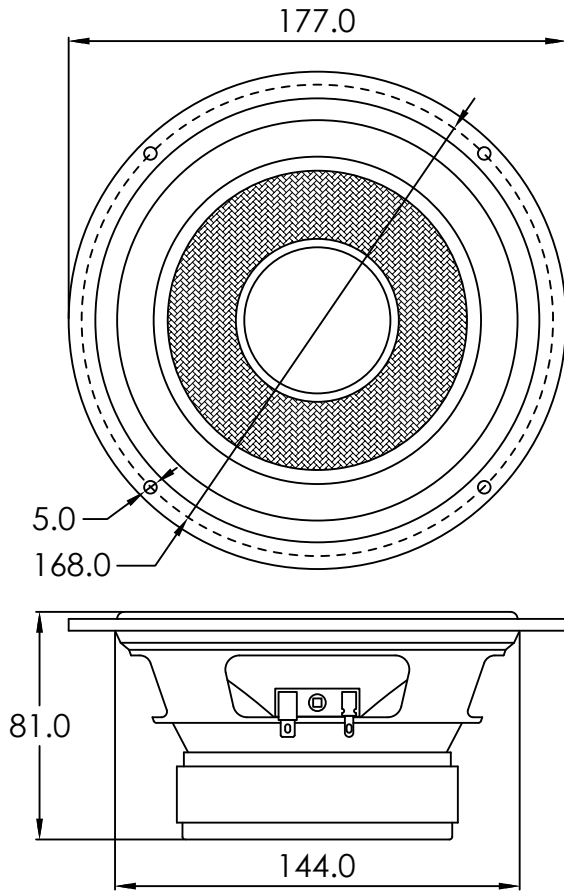

6-1/2" Glass Fiber Cone Woofer 4 Ohm

GF180-4



PARAMETERS	
Impedance	4 ohms
Re	4.4 ohms
Le	1.1 @ 1kHz
Fs	49 Hz
Qms	3.43
Qes	0.48
Qts	0.42
Mms	14.8 g
Cms	0.70 mm/N
Sd	130.2 cm ²
Vd	52.2 cm ³
BL	6.5 Tm
Vas	16.5 liters
Xmax	4 mm
VC Diameter	25 mm
SPL	90.7 @ 2.83V/1m
RMS Power Handling	40 watts
Usable Frequency Range	45 - 5,000 Hz

- FEATURES**
- Woven fiberglass cone lowers resonances for smooth response and natural sound
 - 4-layer voice coil on an aluminum former provides excellent heat dissipation
 - Rubber surround helps damp the cone improving high frequency response
 - Vented pole piece releases air trapped under the dustcap for quiet operation
 - Low-profile frame lowers diffraction for surface mount applications

