

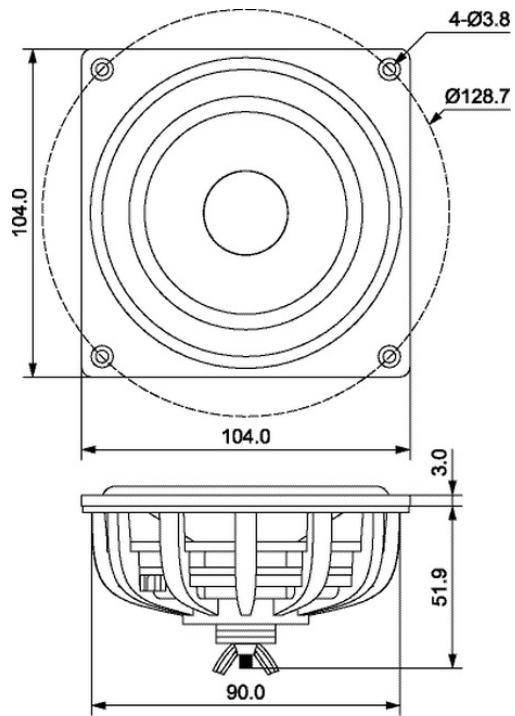

DMA105-PR 4" DMA Series Passive Radiator



FEATURES

- Perfect match for the Dayton Audio DMA series drivers
- Allows tuning small enclosures lower than possible using conventional ports
- Rear mounted threaded post allows easy mass adjustment for custom tuning
- DIY friendly, oversized mounting flange makes installation simple

PARAMETERS

Fs	37.9 Hz
Qms	7.80
Mms	29.3 g
Cms	0.60 mm/N
Sd	54.1 cm ²
Vd	48.7 cm ³
Vas	2.5 liters
Xmax	9 mm
Rms	0.90 kg/s

Note: Parameters above are for the passive only with no additional mass added.